

Fig.18

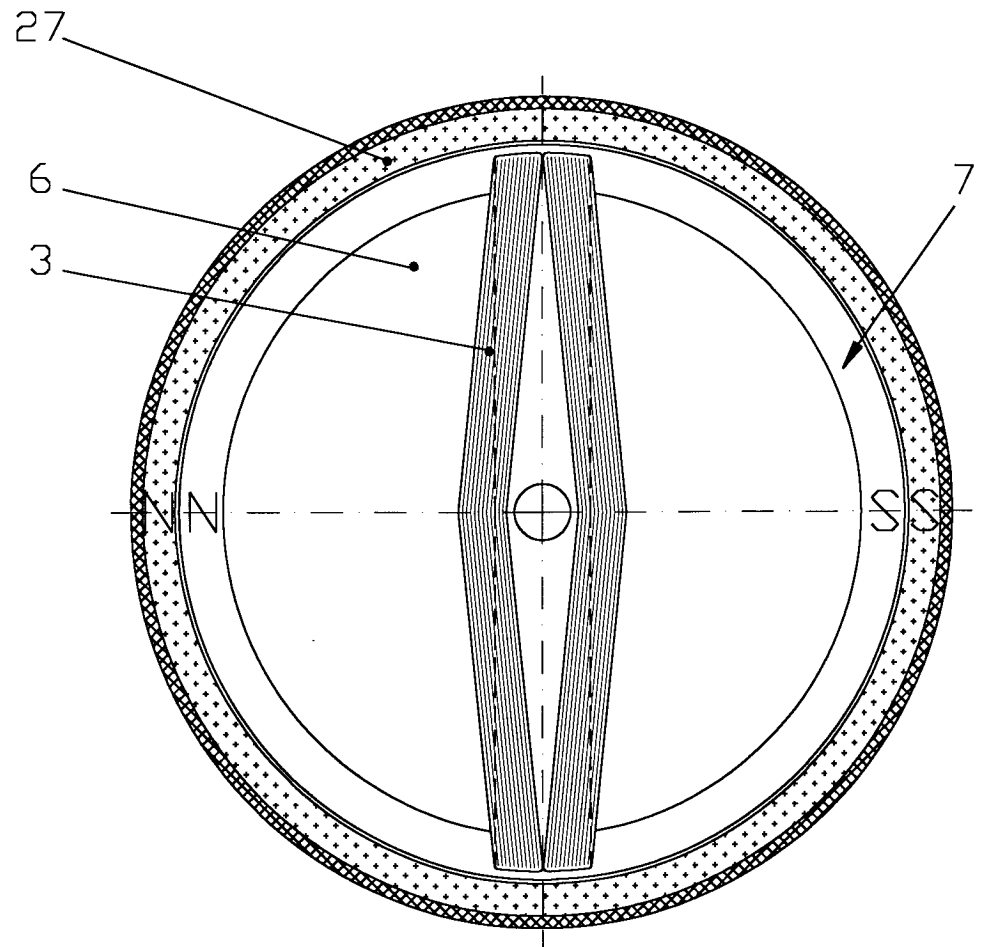

Fig.19