

Fig.7

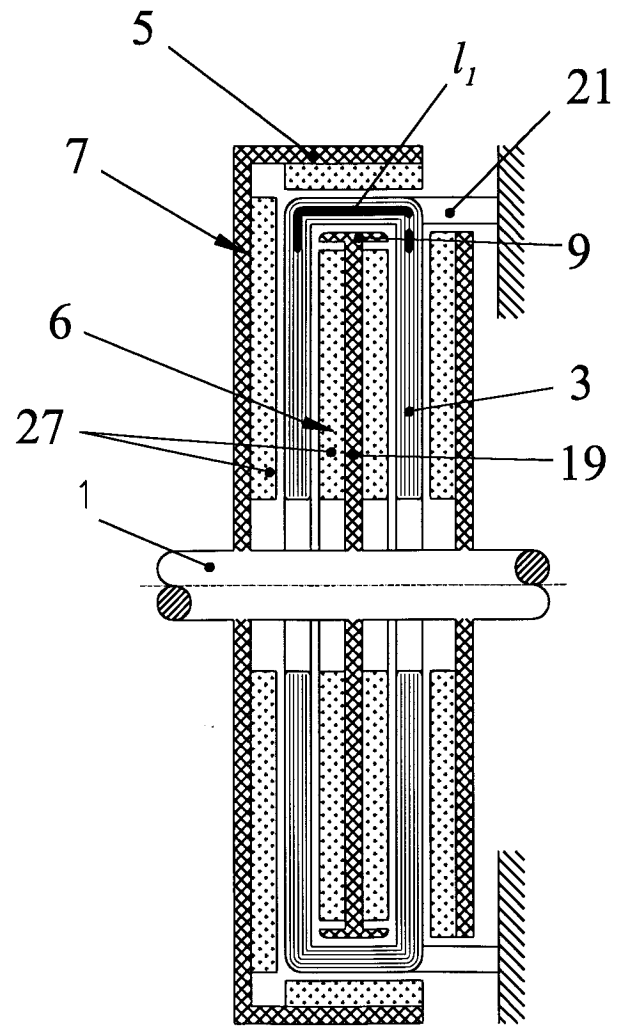

Fig.8