

Fig.9

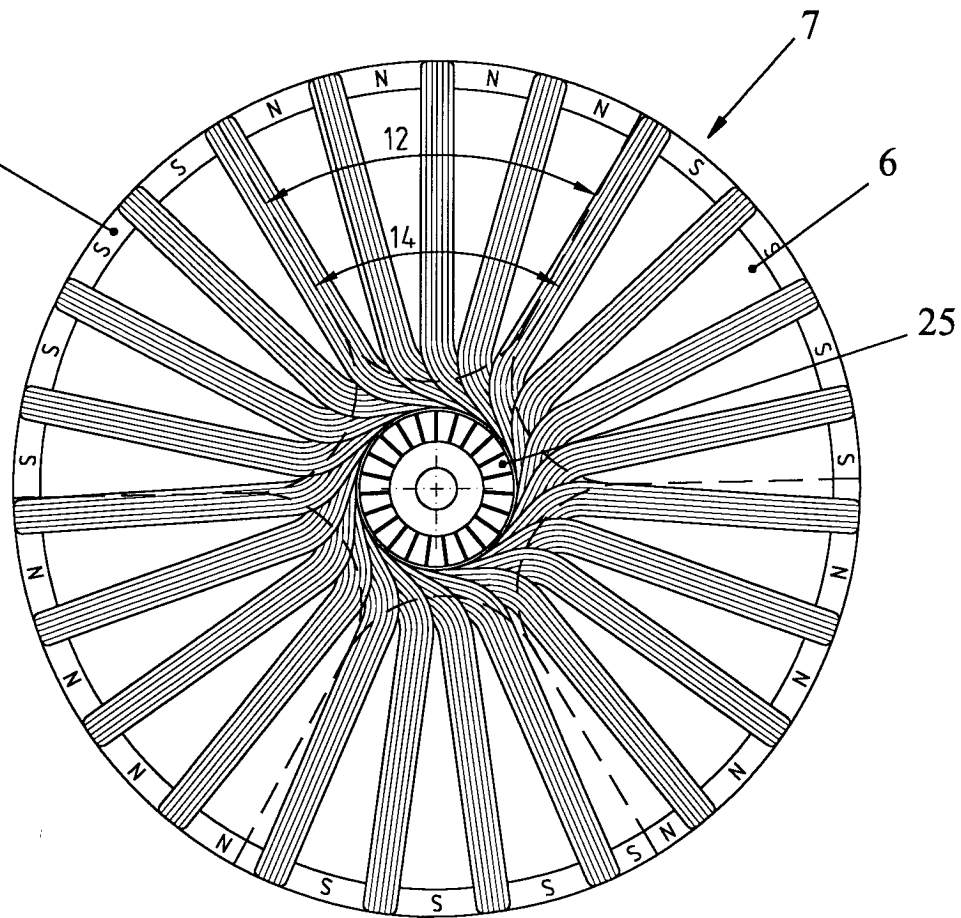

Fig.10